

# FURUNO

# RADAR



Models:  
**FAR-15x8 series**  
(with 15" or 19" LCD)

Photo: 15" LCD MU-152HD



[www.furuno.com](http://www.furuno.com)

## ► Automatic Clutter Elimination (ACE) for unprecedented echo clarity

Quickly adjust the radar image with the push of a single button press. When the ACE function is activated, the system automatically adjusts clutter reduction filters and gain control according to the sea and weather conditions selected by the user (calm/rough sea/ hard rain).

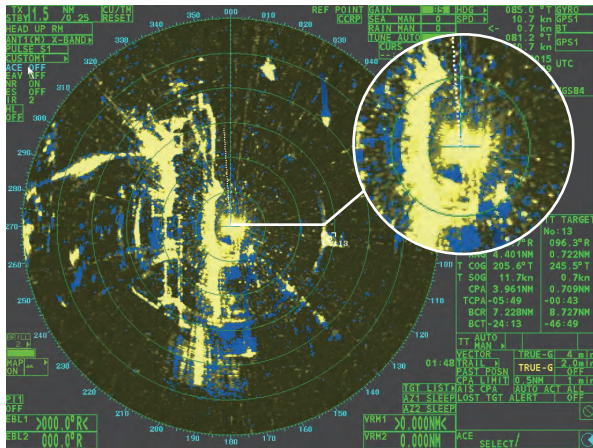

Automatic Clutter Elimination (ACE) OFF

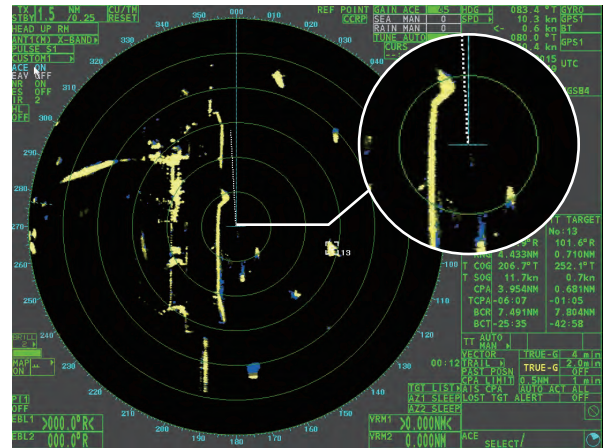

Automatic Clutter Elimination (ACE) ON

## ► Fast Target Tracking™ (TT)

It only takes a few seconds after a target has been selected, that a speed and course vector is displayed. With accurate tracking information, estimation of other vessels' course and speed is made easier.

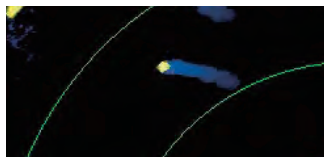

Before selecting a target



Speed and course vector

## ► Customizable data display for efficient and simple operation

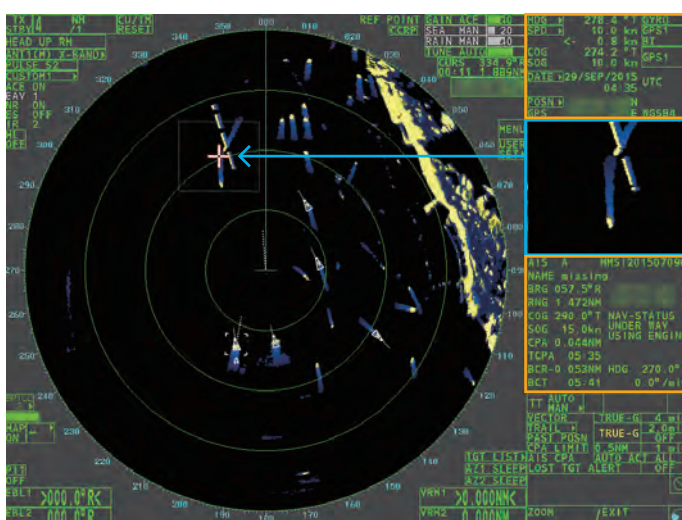

OS data cell

Data cell 1

Close up display

Data cell 2

AIS information

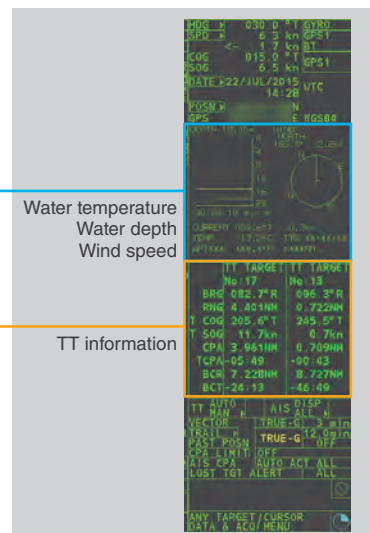

Water temperature  
Water depth  
Wind speed

TT information

## Data display

Whether it be a close up of approaching targets or target information, you can customize the display freely to show the information you need at hand. Up to four TT targets can be displayed as well as two AIS targets, complete with information.

## Close up display (Zoom function)

You can view a close up of a point of interest, enlarged two or three times. Enlarge incoming targets for increased situational awareness. Echo trails can also be displayed in order to further enhance situational awareness in busy shipping lanes.



Excellent target detection,  
improved user interface, made possible  
with the very latest technologies



# RADAR



- ▶ High performance Radar with Cat.2 (500-10,000GT) and Cat.3 (<500GT) support.
- ▶ Accurately tracks other vessels with advanced Target Tracking (TT) function for collision avoidance.
- ▶ Improved sea and rain clutter suppression function.
- ▶ Improved user interface for simple and efficient operation.

## Easy to operate control unit

Simple and efficient operation is made possible with individual knobs for setting gain/rain/sea clutter suppression, as well as a RotoKey and touchpad. The optional trackball unit can also be used.



Rotate to adjust rain reflection, sea surface reflection, gain

Touchpad area

Rotokey and frequently used key



Trackball Control Unit (option)

## FAR-15x8 series

FAR-1518/ FAR-1518-BB X-band, 12 kW, TR up  
FAR-1528/ FAR-1528-BB X-band, 25 kW, TR up

## Antenna Unit



Photo: XN24AF



## ► Scalable Ethernet Network System

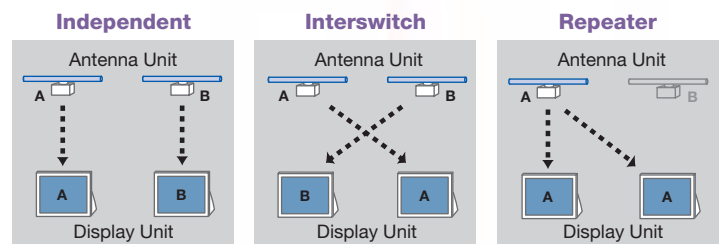
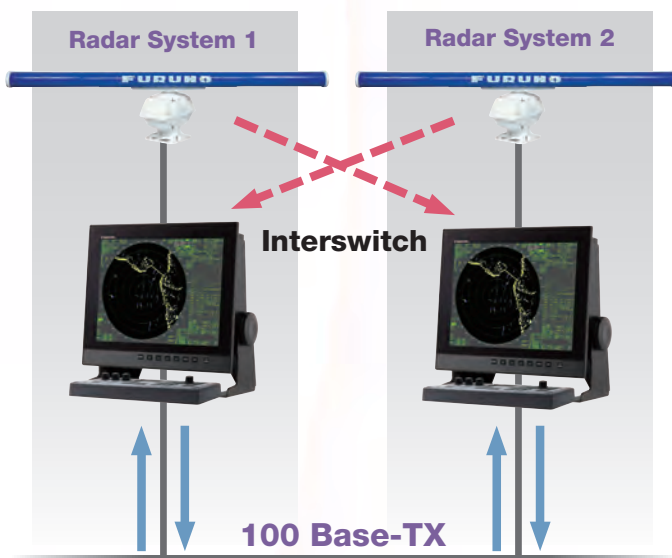

FAR-15x8 series utilizes a 100 Base-TX Ethernet connection to network up to two radar systems together. This Ethernet data link gives high-speed and stable navigational data sharing for interswitching as well as sharing data between ECDIS and GPS plotters.

## ► High visibility monitor MU-190, MU-152HD and MU-152

19" LCD MU-190 (Cat.2), 15" LCD MU-152HD\* and MU-152 (Cat.3) are offered to fit the needs of your vessel.

\*High brightness ensures great visibility in all environments.

## ► AIS connectivity built-in, accurately track targets for increased safety

## ► Display Radar overlay on connected ECDIS

## ► Customizable warning function for CPA/TCPA, Guardzone and more

## ► Conforms to IEC62388 and IEC62288

## SPECIFICATIONS

### PRODUCT NAME MARINE RADAR

#### 1 Antenna Radiators

##### Antenna type

Slotted waveguide array

##### Radiator length

4 ft (XN12AF), 6.5 ft (XN20AF), 8 ft (XN24AF)

##### Horizontal beamwidth

1.9° (XN12AF), 1.23° (XN20AF), 0.95° (XN24AF)

##### Vertical beamwidth

20°

##### Sidelobe attenuation

XN12AF

-24dB(within ±10°),

-30dB(outside ±10°)

XN20/24AF

-28dB(within ±10°)

-32dB(outside ±10°)

##### Polarization

Horizontal

##### Rotation

26 rpm (RSB-120), 48 rpm (RSB-121)

#### 2 RF TRANSCIVER

##### Frequency

9410 MHz ±30 MHz, P0N

##### Output power

##### FAR-1518/FAR-1518-BB

12 kW

##### FAR-1528/FAR-1528-BB

25 kW

##### Minimum range

25 m

##### Range discrimination

25 m

##### Range accuracy

1 % of range in use or 10 m whichever is the greater

##### Bearing accuracy

±1°

##### Range, Pulse length and Pulse Repetition Rate

PRR (Hz approx.)	Range scale (NM)										
	0.125	0.25	0.5	0.75	1.5	3	6	12	24	48	96
3000*	0.08 μs										
2760*	0.12 μs										
1500	0.22 μs										
1000	0.38 μs										
1000	0.68 μs										
600**	1.2 μs										

\*2200 Hz approx. with TT range on 32 NM. \*\*500 Hz on 96 NM range.

##### IF frequency

60 MHz

#### 3 PROCESSOR UNIT

##### Range scales and ring interval

Scale (NM)	0.125	0.25	0.5	0.75	1.5	3	6	12	24	48	96
RI (NM)	0.025	0.05	0.1	0.25	0.25	0.5	1	2	4	8	16
Number of rings	5	5	5	3	6	6	6	6	6	6	6

##### Warm-up time

3 minutes approx

##### Presentation mode

Head-up, STAB Head-up, North-up (TM/RM), Course-up, Stern-up

##### Marks

Cursor, Radar ring, Heading mark, North mark, Bearing line, Vector, Map mark, Zoom, VRM, EBL, Acquisition zone

##### Target tracking (TT)

Auto or manual acquisition: 50 targets in 0.1 - 32NM

Tracking: 5/10 pts on all target

Time of vector: 0 to 60 minutes

##### AIS

Display capacity: 300 targets, Tracking: 5/10 pts on all target

Time of vector: 0 to 60 minutes

##### Echo trail

True/Relative, Trail length: 0 to 30 minutes (30 s steps) or continue

##### Radar map

5,000 pts

##### Interswitch function

Selected from menu

#### 4 MARINE DISPLAY\*

##### Screen size

MU-190	MU-152HD	MU-152
19-inch LCD	15-inch LCD	15-inch LCD

##### Brightness

MU-190	MU-152HD	MU-152
450 cd/m <sup>2</sup>	1000 cd/m <sup>2</sup>	400 cd/m <sup>2</sup>

##### Contrast ratio

MU-190	MU-152HD	MU-152
900:1	2500:1	900:1

##### Radar effective diameter

MU-190	MU-152HD	MU-152
250 mm	213 mm	213 mm

\*The display unit for BB-type should be prepared by user.

#### 5 INTERFACE

##### Number of ports on processor unit

##### Heading

1 port: AD-10 format or IEC61162-2

##### Serial

IEC61162-2: 2 ports (AIS/HDG)

IEC61162-1: 4 ports (GPS/LOG/AMS/ECDIS)

##### Contact closure

Alert output: 4 ch, Remote ACK input, System fail, Power fail

##### Remote display

2 ports (Signal: HD, BP, Trigger and Video)

##### LAN

Ethernet 100Base-TX: 1 port

##### DVI

DVI-D: 1 port for main display

##### RGB

1 port for VDR or RGB monitor

##### Data sentences

##### Input

ABK, ACK, ACN, ALR, BWC, BWR, CUR, DBK, DBS, DBT, DPT, DTM, GBS, GGA, GLL, GNS, HBT, HDG, HDM, HDT, MTW, MWV, RMB, RMC, RTE, THS, VBW, VDM, VDO, VDR, VHW, VTG, VWR, VWT, WPL, ZDA

##### Output

ABM, ACK, ALC, ALF, ALR, ARC, BBM, EVE, HBT, OSD, RSD, TLB, TLL, TTD, TTM, VSD

#### 6 POWER SUPPLY

##### Processor Unit

##### AC type

##### FAR-1518/1518-BB

100-115/220-230 VAC: 1.8/0.8 A (26 rpm), 2.2/1.0 A (48 rpm)

##### FAR-1528/1528-BB

100-115/220-230 VAC: 2.3/1.0 A (26 rpm), 2.6/1.2 A (48 rpm)

##### DC type

##### FAR-1518/1518-BB

24 VDC: 6.1 A max. (26 rpm), 7.2 A max. (48 rpm)

##### FAR-1528/1528-BB

24 VDC: 7.5 A max. (26 rpm), 8.6 A max. (48 rpm)

##### Marine display

MU-152HD: 12-24 VDC 2.5-1.3 A

MU-152: 12-24 VDC 1.9-0.9 A

MU-190: 100-240 VAC 0.7-0.4 A

##### Rectifier (RU-1746B-2/RU-3424, option)

100-115/220-230 VAC, 1 phase, 50/60Hz

##### Transformer (RU-1803, option)

440 VAC, 1 phase, 50/60Hz

#### 7 ENVIRONMENTAL CONDITIONS

##### Ambient temperature

##### Antenna Unit

-25°C to +55°C (storage: +70°C or less)

##### Processor Unit

-15°C to +55°C

##### Marine display

-15°C to +55°C

##### Relative humidity

93% or less at +40°C

##### Degree of protection

##### Antenna Unit

IP56

##### Processor Unit

IP20 (IP22: option)

##### Control Unit

IP22

##### Marine display

IP56 (panel), IP22 (chassis)

##### Vibration

IEC 60945 Ed.4

#### EQUIPMENT LIST

##### Standard supply

1. Display Unit MU-190, MU-152HD, MU-152 (selectable)
2. Processor Unit RPU-024
3. Control Unit RCU-028
4. Antenna Unit with cable, 15/20/30 m (Specify when ordering)
5. For Display Unit, DVI cable (5 m) DVI-D/D S-LINK 5M, not supplied with BB model
6. Standard Spare Parts and Installation Materials

##### Optional supply

1. Trackball Control Unit RCU-030
2. Performance Monitor PM-32A
3. AD Converter AD-100
4. Stepdown Transformer Unit RU-1803
5. AC-DC Power Rectifier  
PR-241/PR-851/RU-3423/RU-1746B-2/RU-3424
6. Radar signal cable (1 m/5 m/10 m/15 m)  
RW-4864 1M/RW-4864 5M/RW-4864 10M/RW-4864 15M
7. For Display Unit, DVI cable (10 m) DVI-D/D S-LINK 10M
8. Switching Hub HUB-100



# INTERCONNECTION DIAGRAM

Antenna Unit (Specify when ordering)

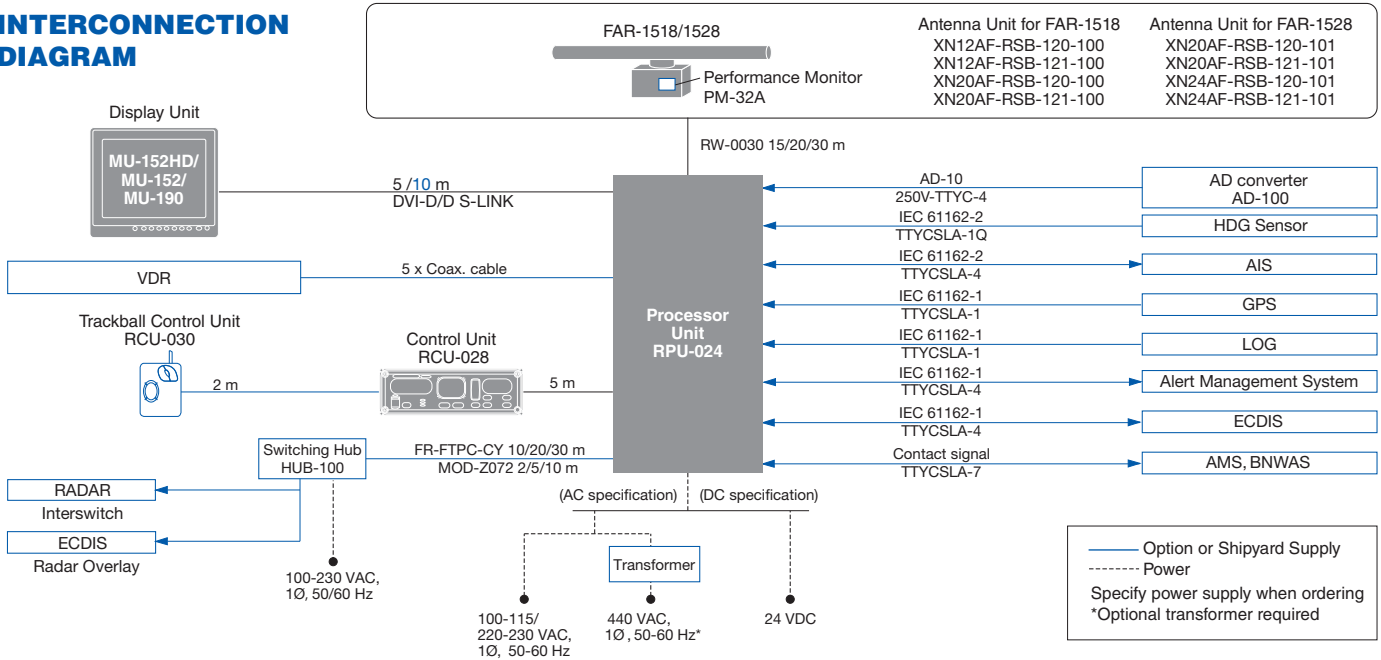

## Antenna Unit for FAR-1518/1528

**XN12AF**  
33 kg 73 lb

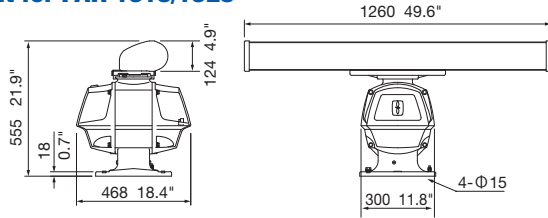

**XN20AF** 39 kg 86 lb  
**XN24AF** 42 kg 93 lb

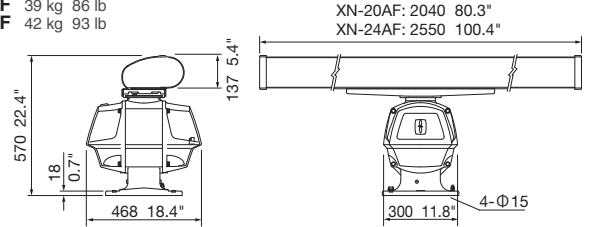

## Processor Unit

**RPU-024**  
DC 6.2 kg 13.7 lb  
AC 6.8 kg 15.0 lb

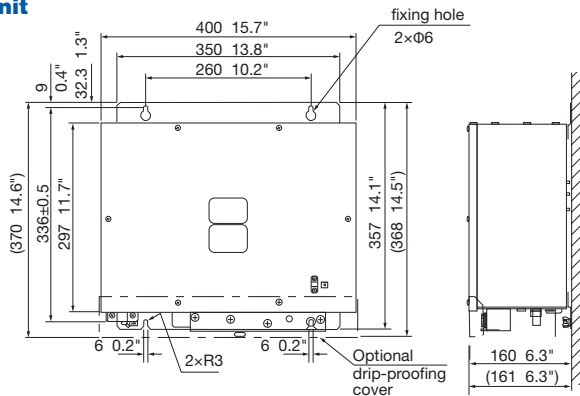

## Display Unit

**MU-190 (Flush mount)**  
8.8 kg 19.4 lb

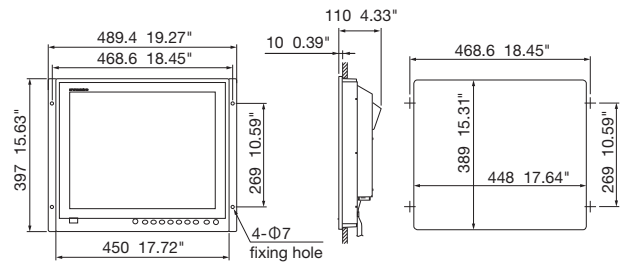

## Control Unit

**RCU-028**  
1.2 kg 2.6 lb

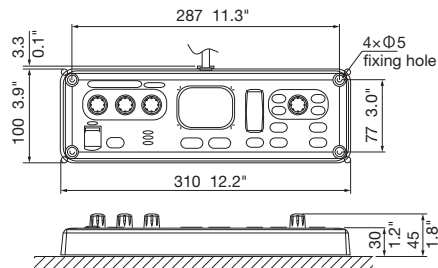

## MU-152HD (Flush mount)

4.5 kg 9.9 lb  
**MU-152 (Flush mount)**  
5.4 kg 11.9 lb

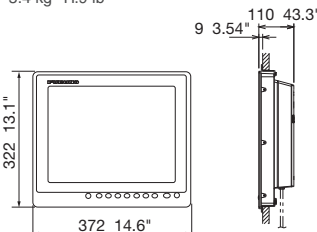

## MU-152

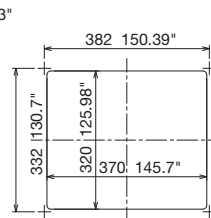

## MU-152HD

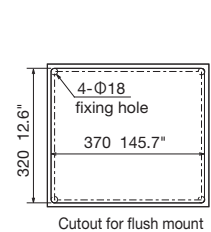

Beware of similar products

All brand and product names are registered trademarks, trademarks or service marks of their respective holders.

SPECIFICATIONS SUBJECT TO CHANGE WITHOUT NOTICE

**FURUNO ELECTRIC CO., LTD.**  
Japan | www.furuno.com

**FURUNO U.S.A., INC.**  
U.S.A. | www.furunousa.com

**FURUNO PANAMA S.A.**  
Republic of Panama | www.furuno.com.pa

**FURUNO (UK) LIMITED**  
U.K. | www.furuno.co.uk

**FURUNO NORGE A/S**  
Norway | www.furuno.no

**FURUNO DANMARK A/S**  
Denmark | www.furuno.dk

**FURUNO SVERIGE AB**  
Sweden | www.furuno.se

**FURUNO FINLAND OY**  
Finland | www.furuno.fi

**FURUNO POLSKA Sp. z o.o.**  
Poland | www.furuno.pl

**FURUNO DEUTSCHLAND GmbH**  
Germany | www.furuno.de

**FURUNO FRANCE S.A.S.**  
France | www.furuno.fr

**FURUNO ESPAÑA S.A.**  
Spain | www.furuno.es

**FURUNO ITALIA S.R.L.**  
Italy | www.furuno.it

**FURUNO HELLAS S.A.**  
Greece | www.furuno.gr

**FURUNO (CYPRUS) LTD**  
Cyprus | www.furuno.com.cy

**FURUNO SHANGHAI CO., LTD.**  
China | www.furuno.com/cn

**FURUNO CHINA CO., LTD.**  
Hong Kong | www.furuno.com/cn

**FURUNO KOREA CO., LTD**  
Korea

**FURUNO SINGAPORE**  
Singapore | www.furuno.sg

**PT FURUNO ELECTRIC INDONESIA**  
Indonesia | www.furuno.id

**FURUNO ELECTRIC (MALAYSIA) SND. BHD.**

Malaysia | www.furuno.my

E-2408LB

Catalogue No. CA00002204